

### ALUMINUM PANEL (DRY JOINT)

**NOTE:**

**LOAD BEARING WALL COMPONENTS OF EITHER: 16GA STEEL STUDS, STRUCTURAL MEMBERS, MINIMUM 5/8" PLYWOOD OR CONCRETE. GYPSUM BOARD AND CEMENT BOARD ARE NOT A STRUCTURAL COMPONENT.**

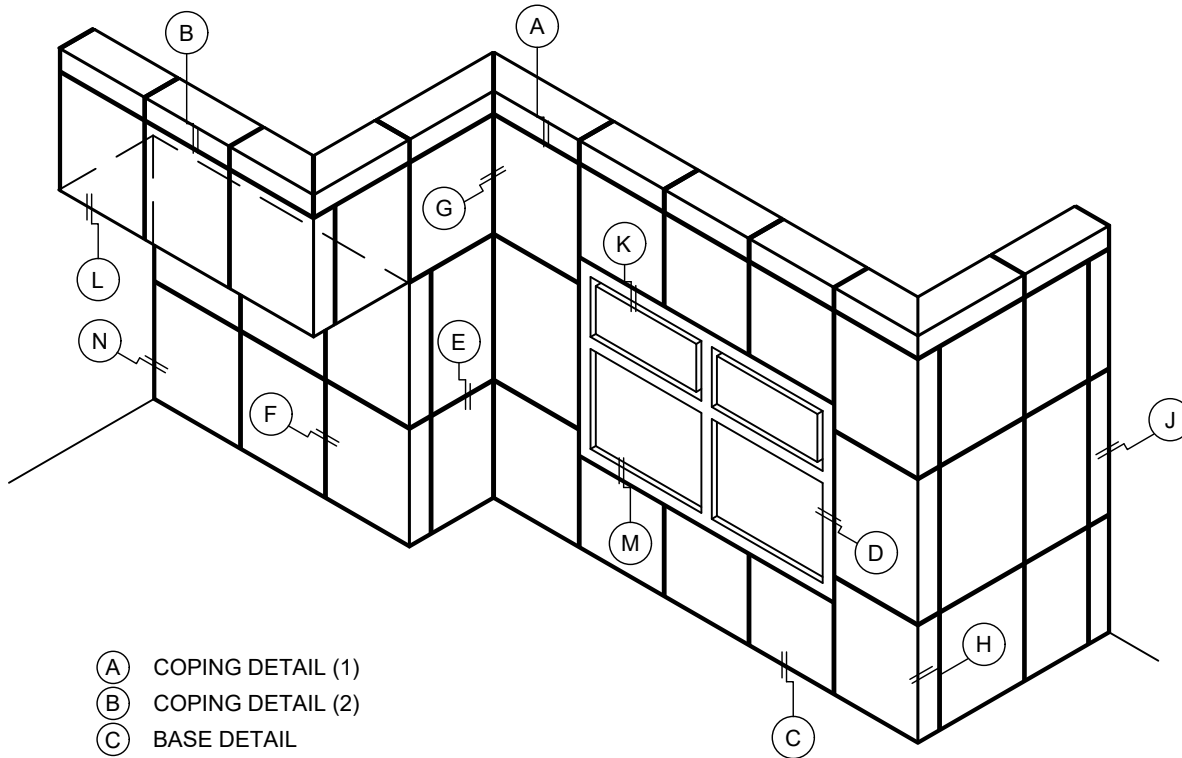

- (A) COPING DETAIL (1)
- (B) COPING DETAIL (2)
- (C) BASE DETAIL
- (D) WINDOW JAMB DETAIL
- (E) FASTENING JOINT DETAIL
- (F) NON - FASTENING JOINT DETAIL
- (G) INSIDE CORNER DETAIL
- (H) OUTSIDE CORNER DETAIL
- (J) END CAP DETAIL
- (K) WINDOW HEAD DETAIL
- (L) SOFFIT TRANSITION DETAIL
- (M) WINDOW SILL DETAIL
- (N) TERMINATION DETAIL



AC-3200  
BACK VENTILATED

## PANEL CONSTRUCTION

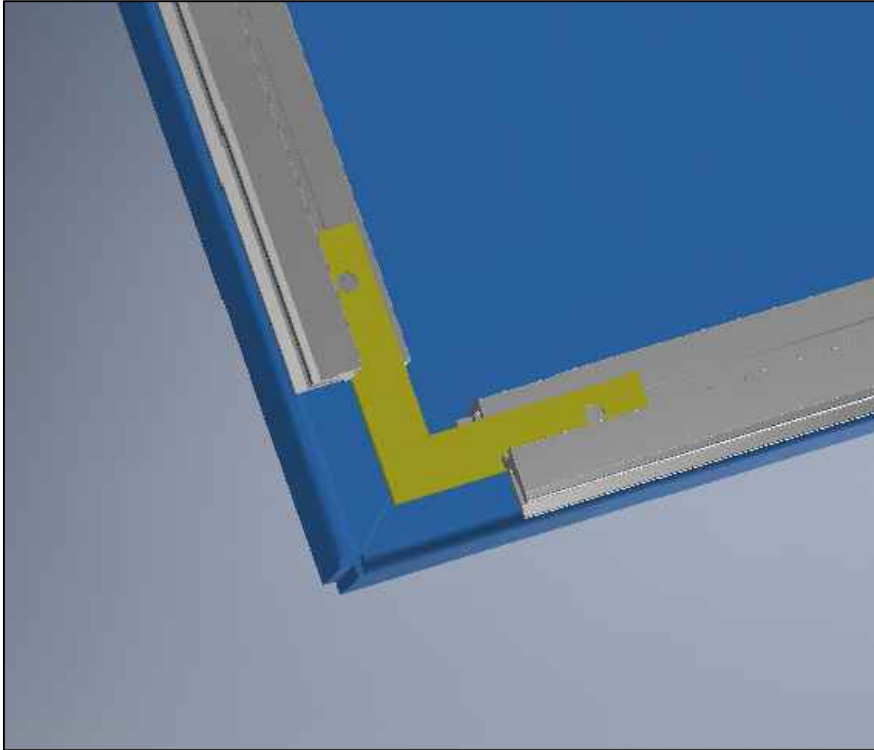

**AC-3200**  
**BACK VENTILATED**

**COPING DETAIL (1)**

**DETAIL A**

**NOTE:**

**LOAD BEARING WALL COMPONENTS OF EITHER: 16GA STEEL STUDS, STRUCTURAL MEMBERS, MINIMUM 5/8" PLYWOOD OR CONCRETE. GYPSUM BOARD AND CEMENT BOARD ARE NOT A STRUCTURAL COMPONENT.**

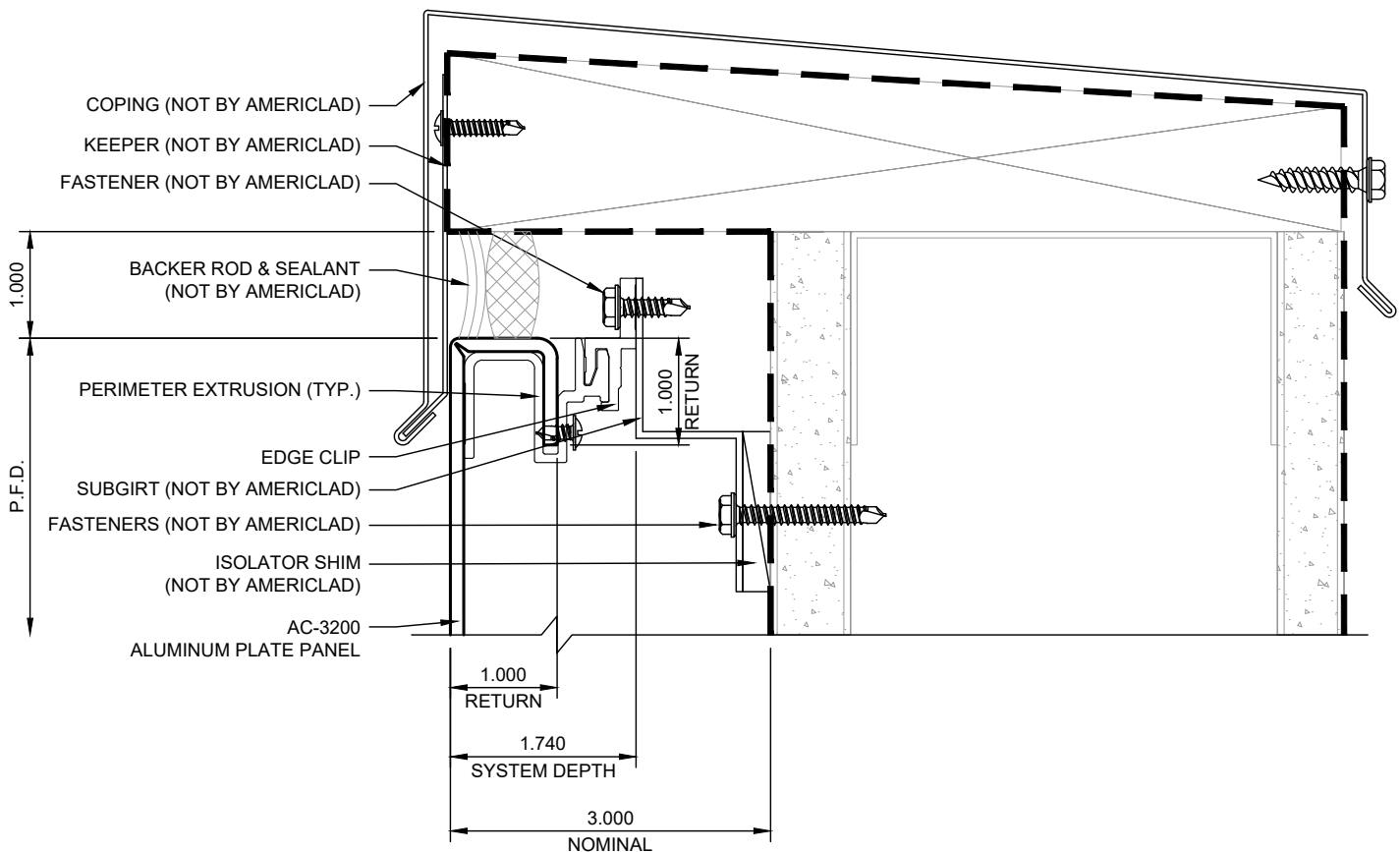

### COPING DETAIL (2)

### DETAIL B

**NOTE:**

**LOAD BEARING WALL COMPONENTS OF EITHER: 16GA STEEL STUDS, STRUCTURAL MEMBERS, MINIMUM 5/8" PLYWOOD OR CONCRETE. GYPSUM BOARD AND CEMENT BOARD ARE NOT A STRUCTURAL COMPONENT.**

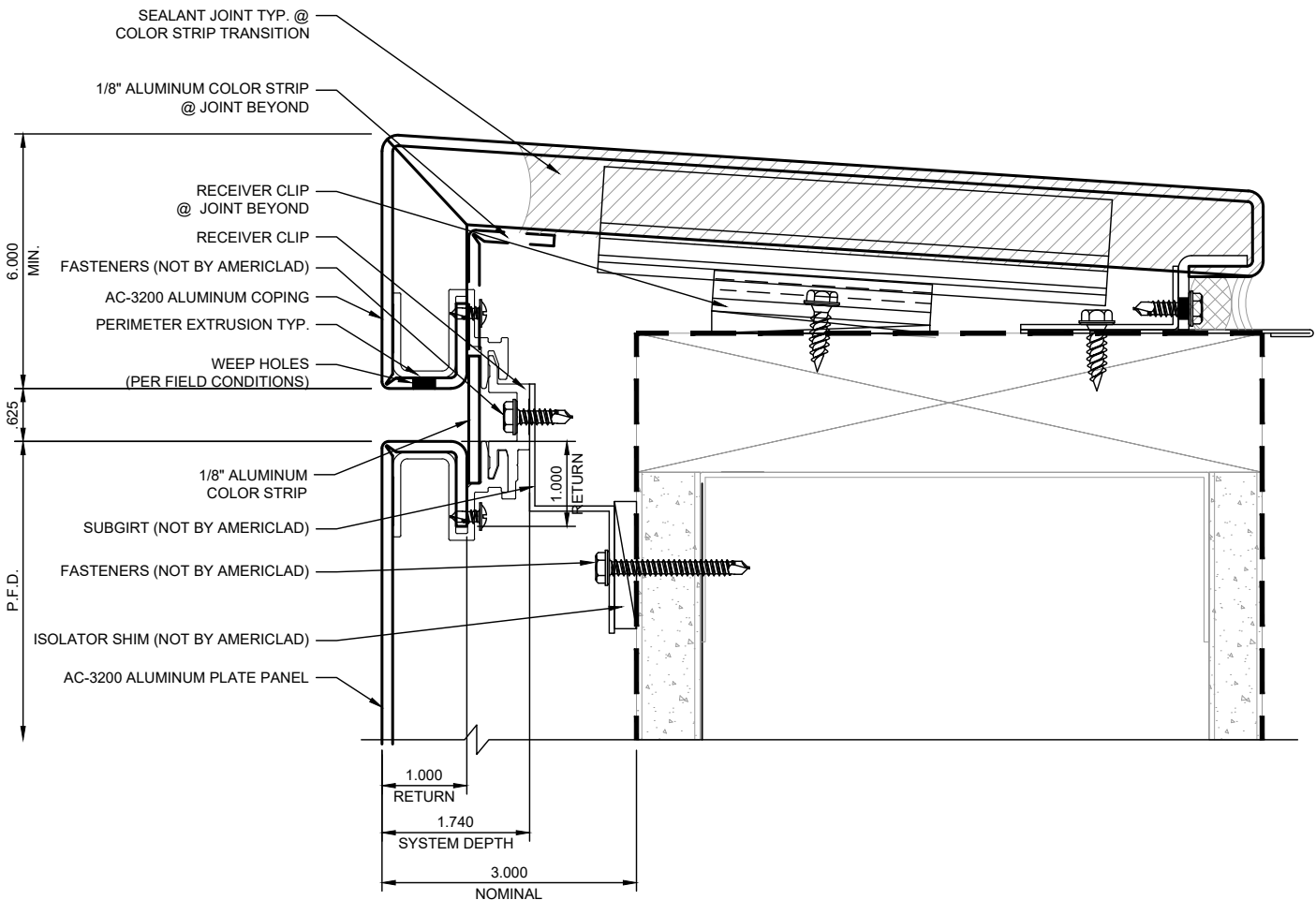

### BASE DETAIL

### DETAIL C

**NOTE:**

**LOAD BEARING WALL COMPONENTS OF EITHER: 16GA STEEL STUDS, STRUCTURAL MEMBERS, MINIMUM 5/8" PLYWOOD OR CONCRETE. GYPSUM BOARD AND CEMENT BOARD ARE NOT A STRUCTURAL COMPONENT.**

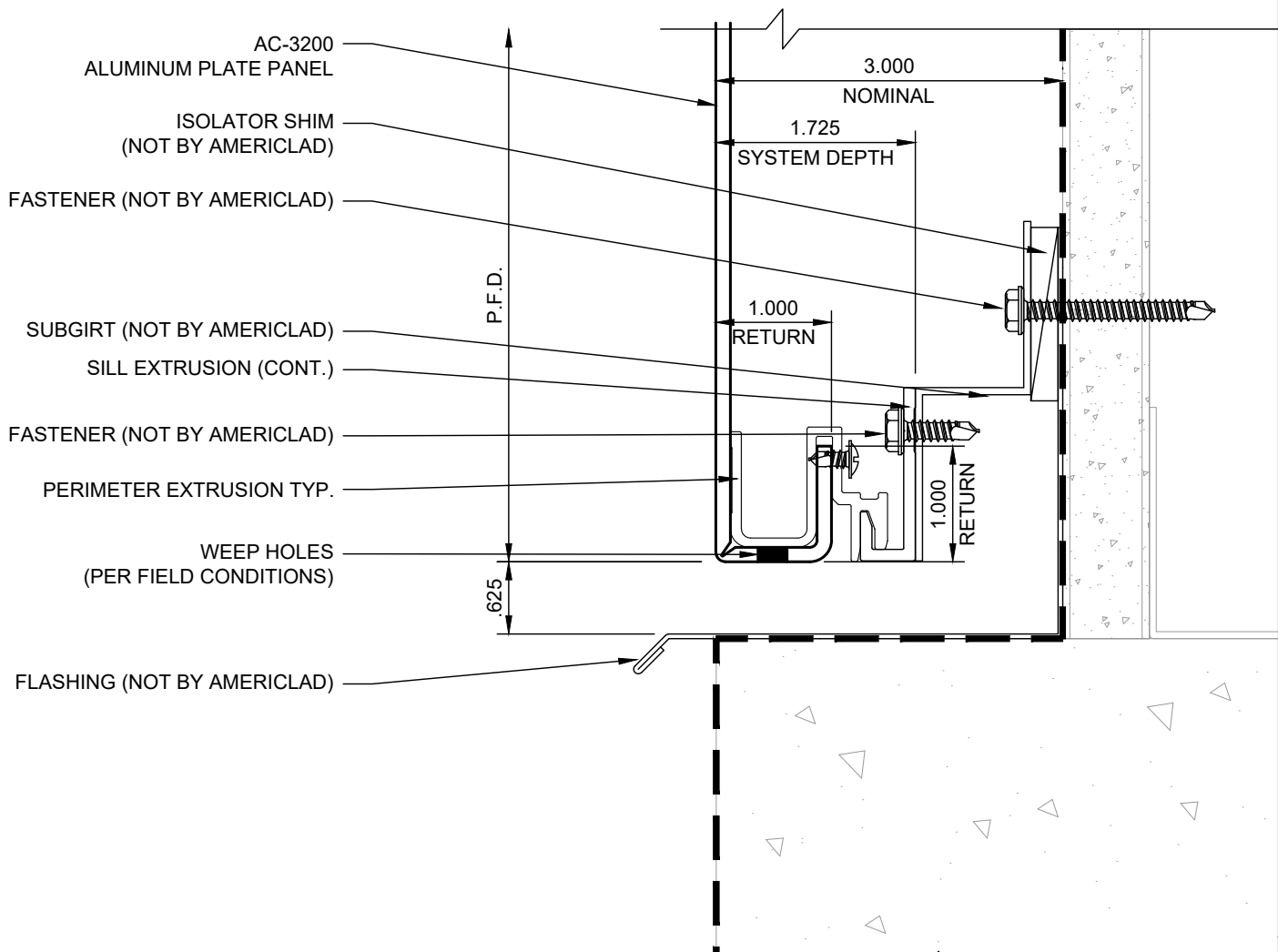

### WINDOW JAMB DETAIL

### DETAIL D

**NOTE:**

**LOAD BEARING WALL COMPONENTS OF EITHER: 16GA STEEL STUDS, STRUCTURAL MEMBERS, MINIMUM 5/8" PLYWOOD OR CONCRETE. GYPSUM BOARD AND CEMENT BOARD ARE NOT A STRUCTURAL COMPONENT.**

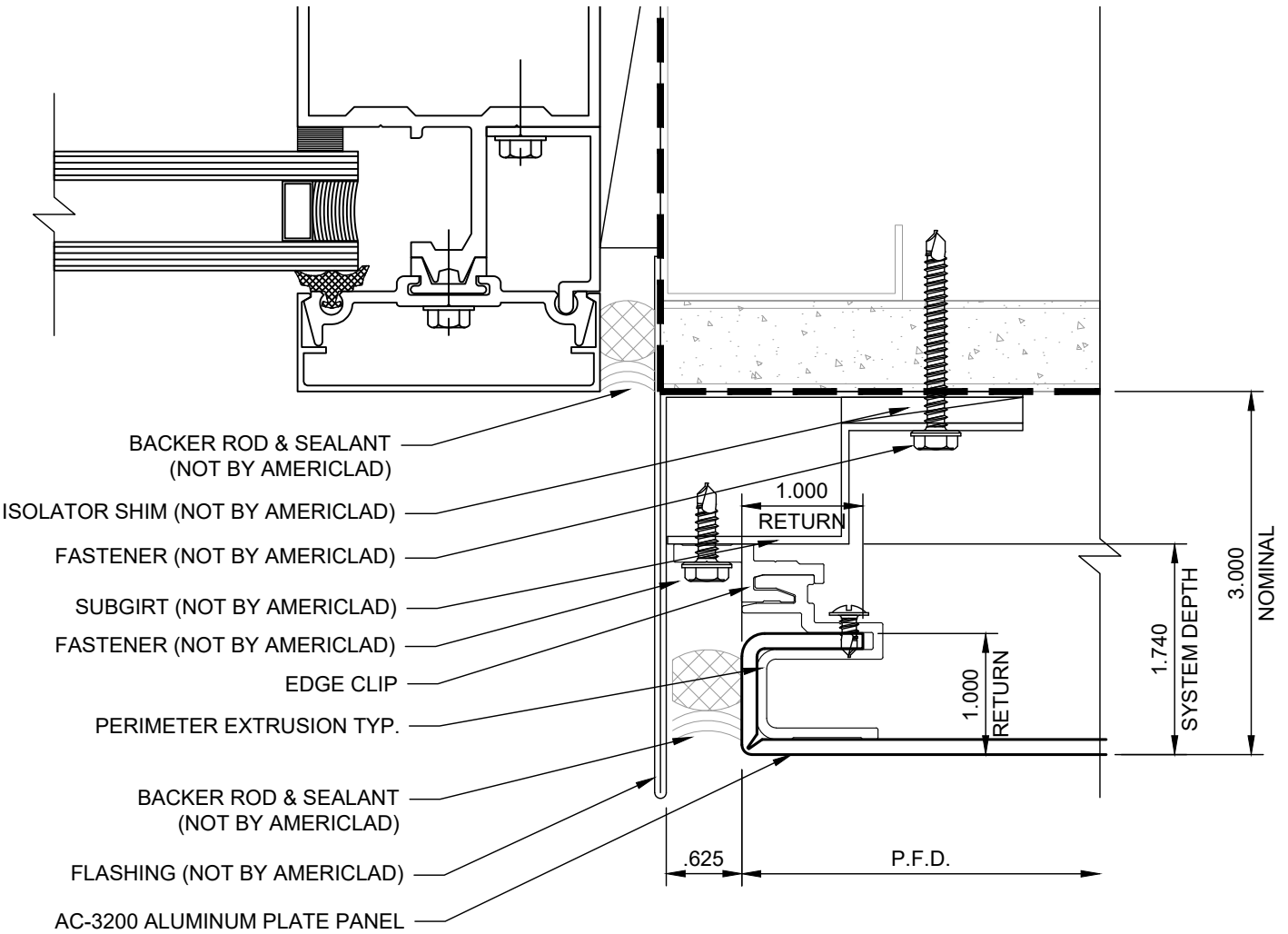

### FASTENING JOINT DETAIL

### DETAIL E

**NOTE:**

**LOAD BEARING WALL COMPONENTS OF EITHER: 16GA STEEL STUDS, STRUCTURAL MEMBERS, MINIMUM 5/8" PLYWOOD OR CONCRETE. GYPSUM BOARD AND CEMENT BOARD ARE NOT A STRUCTURAL COMPONENT.**

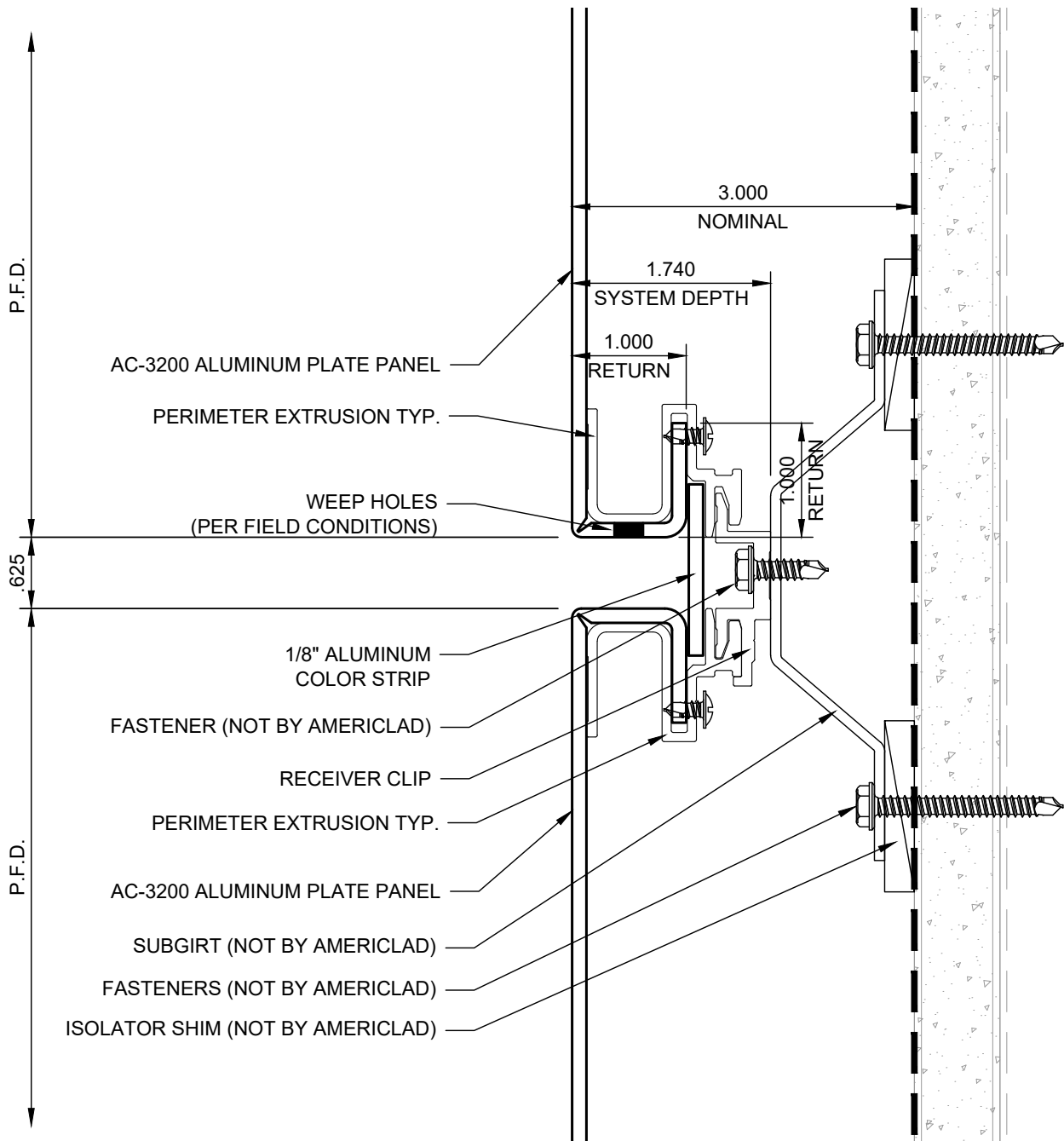



AC-3200  
BACK VENTILATED

NON - FASTENING JOINT DETAIL

DETAIL F

**NOTE:**

**LOAD BEARING WALL COMPONENTS OF EITHER: 16GA STEEL STUDS, STRUCTURAL MEMBERS, MINIMUM 5/8" PLYWOOD OR CONCRETE. GYPSUM BOARD AND CEMENT BOARD ARE NOT A STRUCTURAL COMPONENT.**

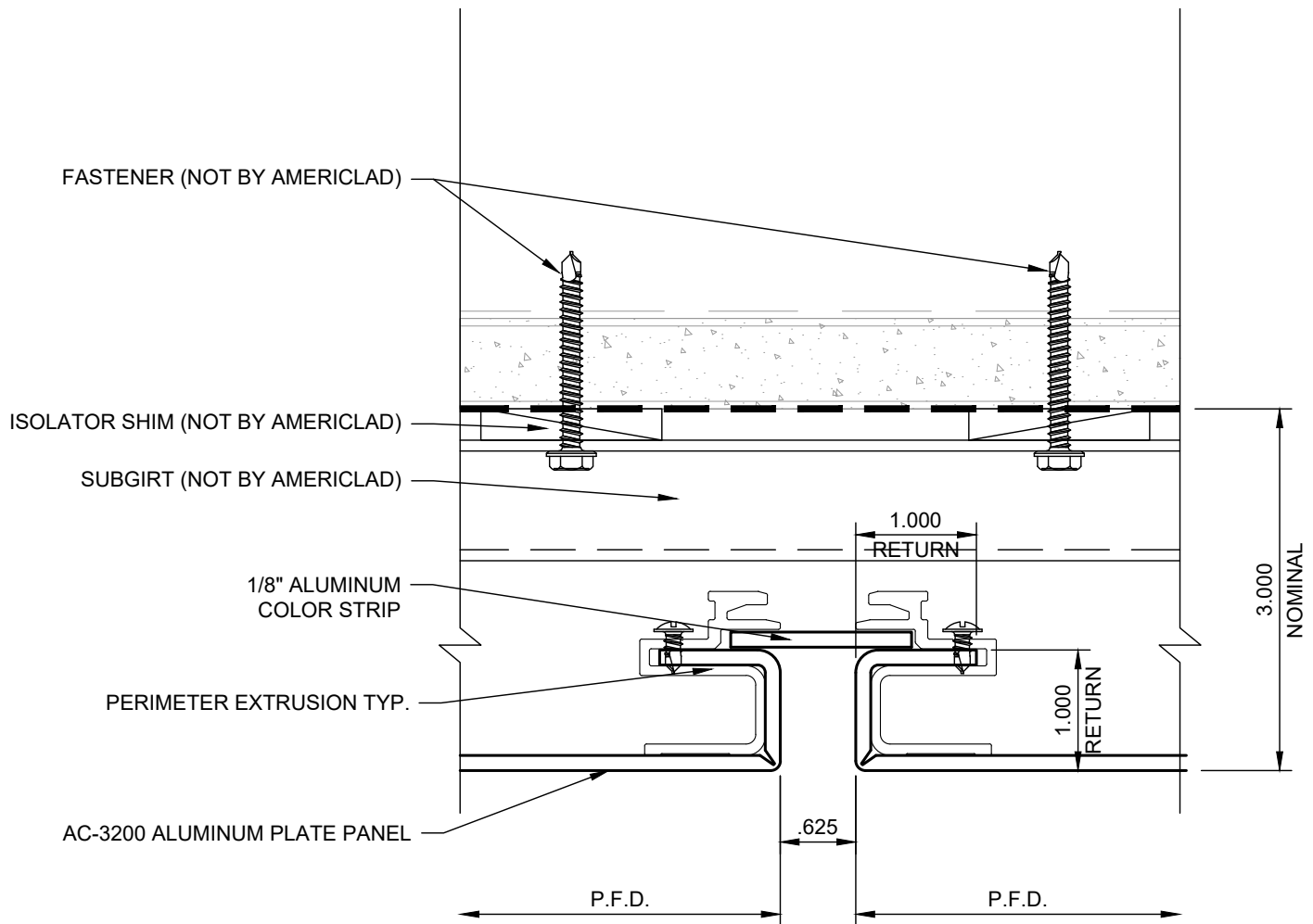



### INSIDE CORNER DETAIL (PLAN)

### DETAIL G

**NOTE:**

**LOAD BEARING WALL COMPONENTS OF EITHER: 16GA STEEL STUDS, STRUCTURAL MEMBERS, MINIMUM 5/8" PLYWOOD OR CONCRETE. GYPSUM BOARD AND CEMENT BOARD ARE NOT A STRUCTURAL COMPONENT.**

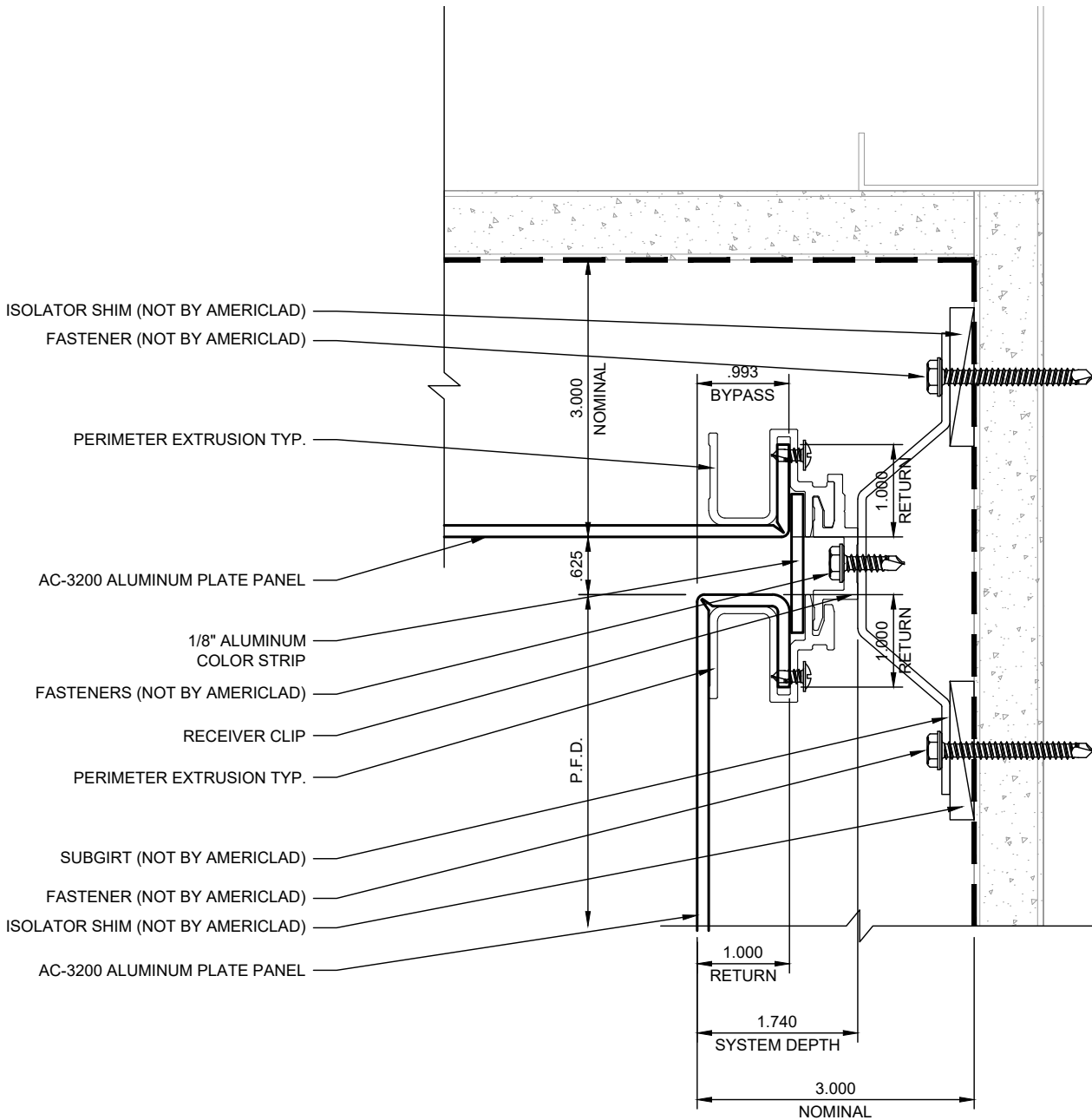



**AC-3200**  
**BACK VENTILATED**

**OUTSIDE CORNER DETAIL**

**DETAIL H**

**NOTE:**

**LOAD BEARING WALL COMPONENTS OF EITHER: 16GA STEEL STUDS, STRUCTURAL MEMBERS, MINIMUM 5/8" PLYWOOD OR CONCRETE. GYPSUM BOARD AND CEMENT BOARD ARE NOT A STRUCTURAL COMPONENT.**

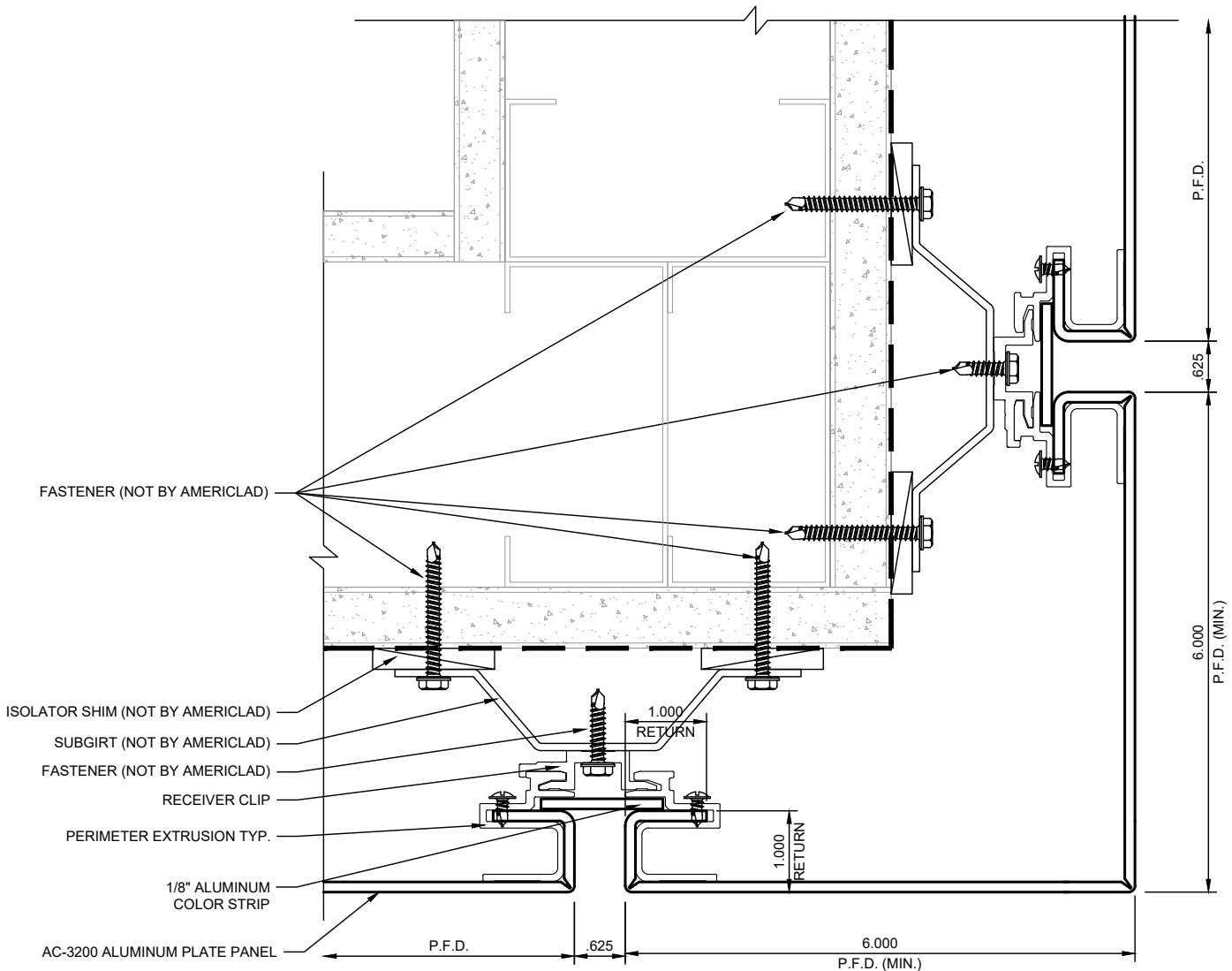

**AC-3200**  
**BACK VENTILATED**

**END CAP DETAIL**

**DETAIL J**

**NOTE:**

**LOAD BEARING WALL COMPONENTS OF EITHER: 16GA STEEL STUDS, STRUCTURAL MEMBERS, MINIMUM 5/8" PLYWOOD OR CONCRETE. GYPSUM BOARD AND CEMENT BOARD ARE NOT A STRUCTURAL COMPONENT.**

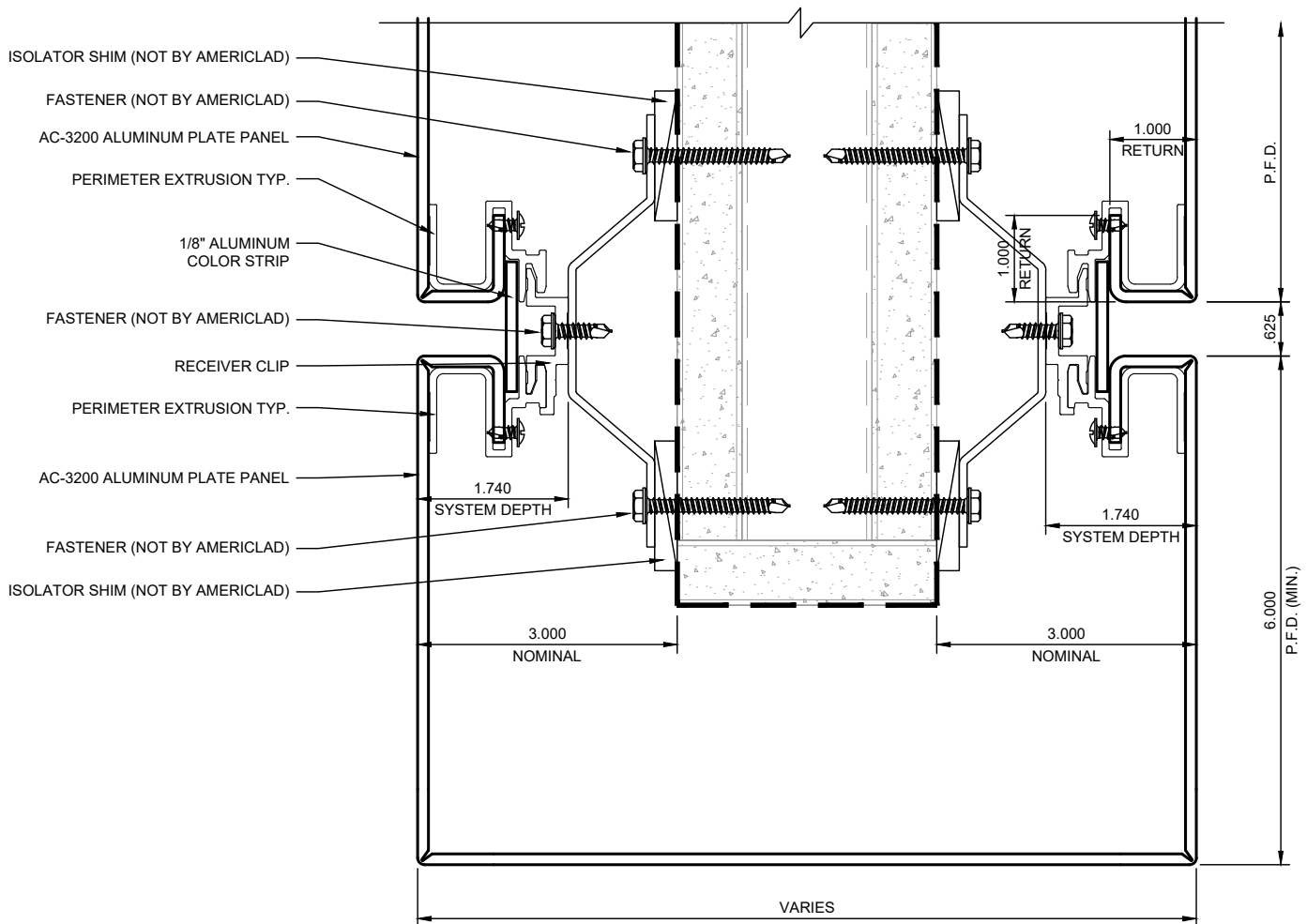

### WINDOW HEAD DETAIL

### DETAIL K

**NOTE:**

**LOAD BEARING WALL COMPONENTS OF EITHER: 16GA STEEL STUDS, STRUCTURAL MEMBERS, MINIMUM 5/8" PLYWOOD OR CONCRETE. GYPSUM BOARD AND CEMENT BOARD ARE NOT A STRUCTURAL COMPONENT.**

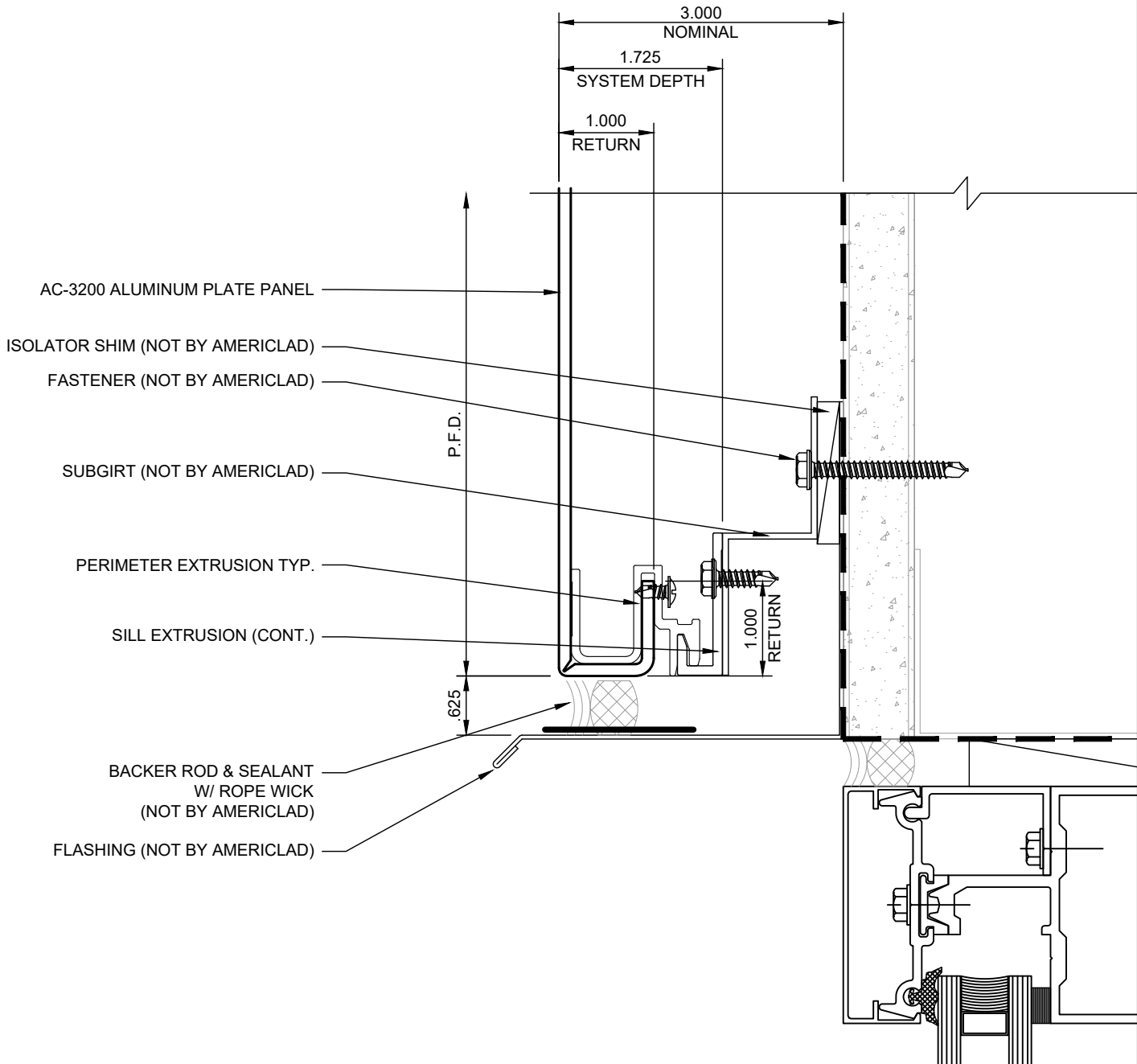

### SOFFIT TRANSITION DETAIL

### DETAIL L

**NOTE:**

**LOAD BEARING WALL COMPONENTS OF EITHER: 16GA STEEL STUDS, STRUCTURAL MEMBERS, MINIMUM 5/8" PLYWOOD OR CONCRETE. GYPSUM BOARD AND CEMENT BOARD ARE NOT A STRUCTURAL COMPONENT.**

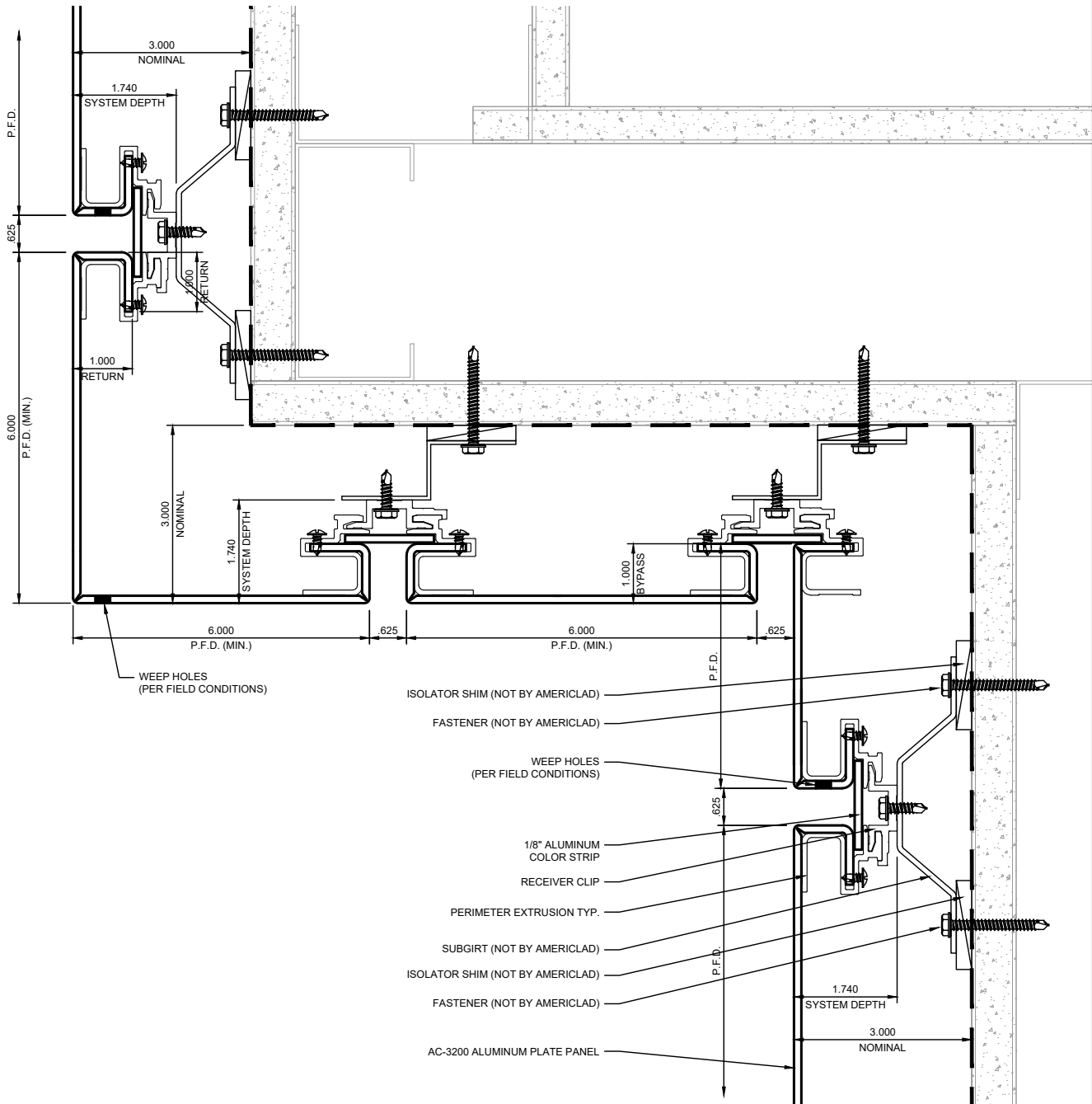

### WINDOW SILL DETAIL

### DETAIL M

**NOTE:**

**LOAD BEARING WALL COMPONENTS OF EITHER: 16GA STEEL STUDS, STRUCTURAL MEMBERS, MINIMUM 5/8" PLYWOOD OR CONCRETE. GYPSUM BOARD AND CEMENT BOARD ARE NOT A STRUCTURAL COMPONENT.**

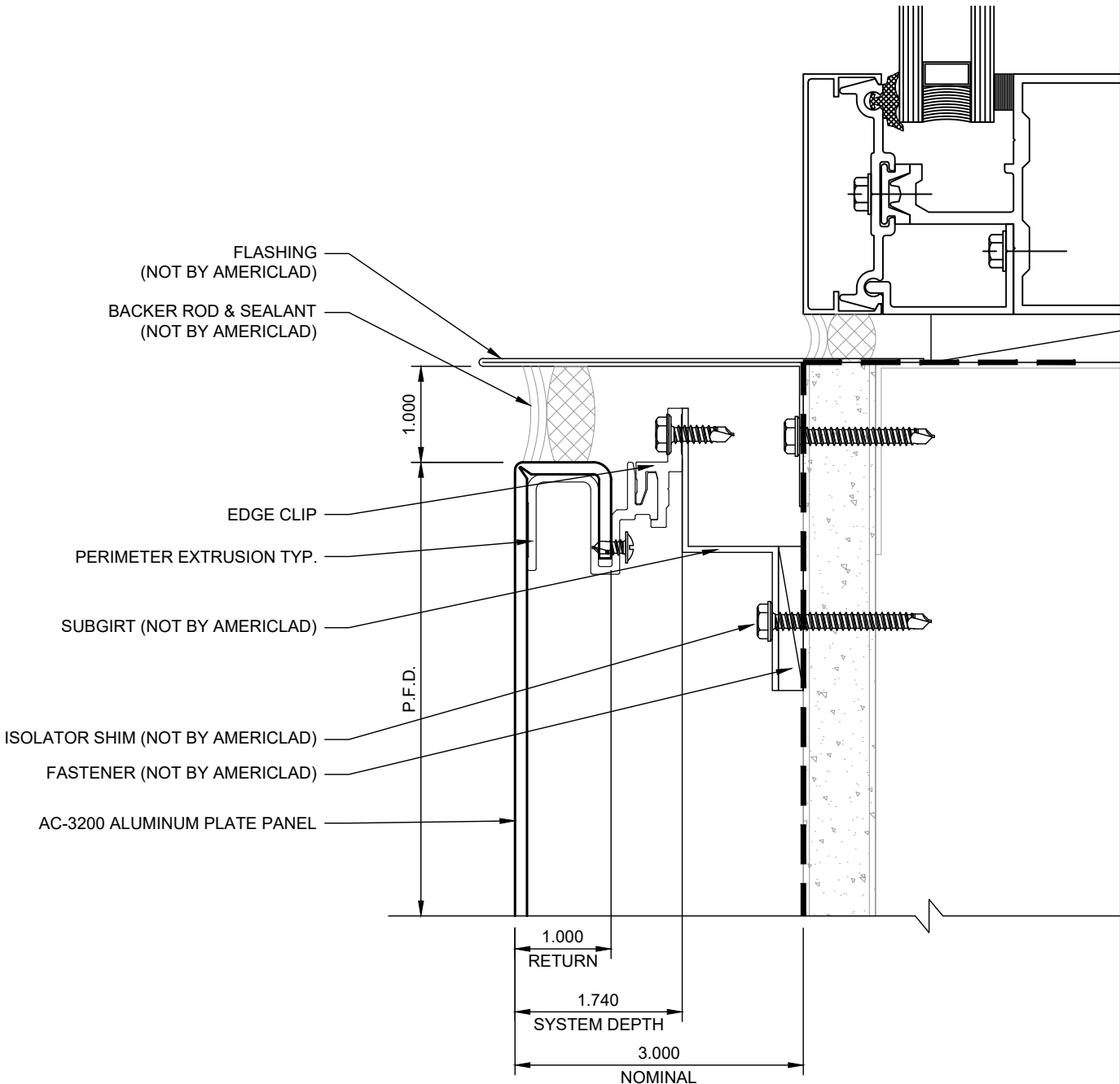

**AC-3200**  
**BACK VENTILATED**

**TERMINATION DETAIL**
**DETAIL N**
**NOTE:**

**LOAD BEARING WALL COMPONENTS OF EITHER: 16GA STEEL STUDS, STRUCTURAL MEMBERS, MINIMUM 5/8" PLYWOOD OR CONCRETE. GYPSUM BOARD AND CEMENT BOARD ARE NOT A STRUCTURAL COMPONENT.**

